

SK2+ Red-Green Home Signal self assembly kit

CAUTION - ALWAYS SWITCH OFF POWER TO YOUR LAYOUT BEFORE CONNECTING OR DISCONNECTING ANY ACCESSORIES

This Self assembly signal kit contains an plastic kit, post and LED Light circuit board with resistor to make a Colour Light signal designed for use on OO/HO gauge model railways - please read these instructions before assembly and connecting to power.

1

Introduction

Contents

- 1 Plastic Signal kit
- 1 Aluminium signal post
- 1 Signal LED lights printed circuit board 'PCB'
- 1 1KΩ resistor (Colour: Black Brown Red Gold)
- 1 Instruction leaflet

Recommended tools (not included)

- Sharp craft knife or cutters
- Small needle file, tweezers or small pliers
- Adhesives to suit plastic/metal (see below)
- Magnifier
- Cutting mat

Thank you for purchasing one of our self assembly signal kits. This kit is an all new design based on an actual colour light signal near our base in Norfolk and is fairly typical of British outline colour light signals and designed to scale with the red light in line with the train drivers eye, just like the real thing. We have utilised the latest LEDs for the lights but unlike most signal kits we have presoldered them on narrow printed circuit boards which makes them much easier to assemble and connect. They are also more realistic being uncoloured until lit and have an integral lens so they shine brighter faced from the front.

You can either control this signal using conventional Lever frame or Toggle type switches or connect it to a DCC decoder to control it from a Digital controller or computer. (note that Train-Tech also offer this signal with a built-in DCC decoder which just plugs straight into the track - no wires or circuitry!)

! Take extra care when using tools and adhesives.

Construction advice

The plastic part of this kit is made of a blend of mostly ABS which is slightly more forgiving and less brittle than the polystyrene often used for plastic kits. However it can still be glued together using most general model kit adhesives such as Humbrol or Revell Liquid Poly or 'super glue' - be sure to follow instructions for application and safety supplied with the adhesive. Note that if fixing accessories to the aluminium post, such as the phone or sign, you will need to use a glue which is suitable for bonding plastic to metal. To remove parts from the sprue we suggest using either precision wire/model cutters (available from dcpexpress.com and model or tool suppliers) or a sharp knife working on a scrap of wood or cutting mat. Some fragile parts, such as the ladder, may be more easily prepared by first removing the part with its larger plastic moulding supports attached, then carefully removing the part from the supports. If you wish to paint any parts most model enamel paints should work fine but if unsure check on a small piece of scrap plastic first. Please note that we cannot help customers assemble kits, but if you have difficulties making kits we suggest you try contacting your local model club for assistance.

We recommend first cutting thicker supports to release main parts then trimming off the small supports using a sharp craft knife or cutters

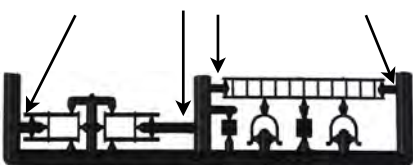

Mounting the signal on your baseboard

You will need to drill a hole in your baseboard to clear the signal PCB - we recommend a 6-8mm hole so that the signal can be lifted with wires still fitted if required. The signal can be free standing or held by suitable glue or double sided sticky pad.

2

Assembling the kit

The exploded diagram below shows all the various components which go to make up a complete signal, although you can fit as few or as many of the detailing parts as you wish for your model. We recommend you read the construction advice below on how to remove parts, adhesives etc.

Suggested order of assembly:

- Slide LED PCB through slot in head mount
- Push fit or glue head mount onto aluminium post
- Push fit post into main base plate and align
- Glue front and back of head cover over LED's
- Dry fit or glue ladder between head mount & base
- Glue base cover under base if desired
- Glue handrails, phone, location board if desired

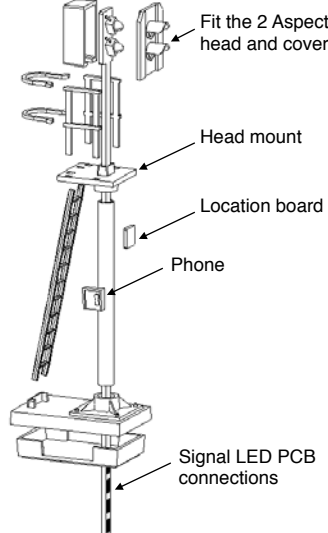

Wiring advice

Electrical connection to the signal is via metal 'pads' at the bottom of the LED light PCB. These pads are made from thin copper bonded to the fibreglass and then 'tinned' to ensure reliable and easy connection.

The best method of connection is by soldering wires onto these pads using a small tip soldering iron of 18-25 watts, taking care not to apply heat for too long. Note that by pre-tinning wires before soldering onto the pads you will find that the solder will flow much more easily to make a secure joint quickly.

If you prefer not to solder then you can wrap thin stranded wire around the pads by stripping off insulation, twisting strands tightly together and wrapping them round the signal base and tightly binding insulation tape around each joint. However soldering is the preferred and most reliable method.

Whichever method you use take care not to let the wires short circuit to each other and do not forget to fit a resistor in series as shown before powering up your new signal!

Location board labels

These legends can be cut out and glued to the model Location board on the plastic detailing sprue. If using DCC we suggest you use the address you have programmed into your signal decoder which will make the signal easier to identify and operate.

1	2	3	4	5	6	7	8	9	10
11	12	13	14	15	16	17	18	19	20
21	22	23	24	25	26	27	28	29	30
31	32	33	34	35	36	37	38	39	40
41	42	43	44	45	46	47	48	49	50
51	52	53	54	55	56	57	58	59	60
61	62	63	64	65	66	67	68	69	70
71	72	73	74	75	76	77	78	79	80
81	82	83	84	85	86	87	88	89	90
91	92	93	94	95	96	97	98	99	100
AD	CA	DA	ES	EN	GE	GY	MY	PN	NW
ABC	DEF	GHI	JKL	MNO	PQRST	UVW	XYZ		
ABC	DEF	GHI	JKL	MNO	PQRST	UVW	XYZ		

3

Connecting the signal

The LED lights are presoldered onto a PCB which has large contacts at the base to connect your wires to. You can either control it by conventional Lever or Toggle switches or alternatively a digital decoder (eg Train-Tech SC1) if you wish to control it using a DCC controller or computer - follow the connection instructions supplied with the decoder.

You MUST fit a resistor as shown below and power from a DC supply or DCC decoder or you will cause permanent damage to the LEDs (Unless using with Train-Tech DCC Signal controllers which incorporate resistors inside)

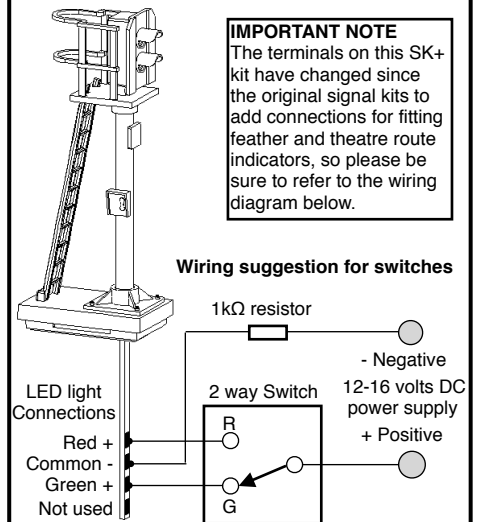

IMPORTANT NOTE
The terminals on this SK+ kit have changed since the original signal kits to add connections for fitting feather and theatre route indicators, so please be sure to refer to the wiring diagram below.

Using LEDs with model railways

The lights used in this signal kit are called LEDs. LEDs are really useful lights which, unlike their conventional filament predecessors, are robust, low power and if used correctly run cool and can effectively last forever.

But there are some important considerations when using LEDs. Firstly LED stands for Light Emitting Diode and a diode is an electronic component which only works in when power is applied in one specific direction, so they always need to be fitted the correct way round to work correctly.

Also most standard miniature LEDs a modeller will use only need very small amounts of power, so the current flowing through the LED must be limited and this is usually done by a resistor as supplied in this kit. On the usual 12-16 volts DC supply a railway modeller uses a 1kΩ (one thousand ohms) will limit the current to around 10-14mA (mA is thousandths of an amp) which is ideal for most LED's.

Note you should only ever use LEDs on a DC (direct current) supply and never an AC (alternating current) supply because although the LED may appear to work properly constant reversal of voltage using AC will eventually damage or shorten its life.

Train-Tech offers packs of various LEDs for modellers and again these always come with both instructions and suitable resistors for using them on a standard Model Railway DC supply or non Train-Tech DCC controllers.

Using Signals with Train-Tech DCC controllers

Train Tech offer various LED controllers including the SC1 and SC2 DCC signal controllers which allow signals such as this to quickly and easily connect to DCC layouts for control by Digital controller or computer. They are quick to connect needing no resistors or soldering and set up in seconds with no programming of CV codes.

As well as Signal Controllers, Train-Tech also makes a range of LFX LED lighting controllers which work on both DC and DCC and offer effects to simulate level crossings, welding, traffic lights etc - again resistors are built into all of the LFX units and so LEDs connect directly to them. See www.train-tech.com for full details.

Track Tester

DC & DCC OO HO N

Only £5



Track not included

- Quickly tests track for power faults
- Low cost and easy to use
- Works on N, TT, OO or HO Track
- Indicates the DC polarity, or DCC, or a fault
- Small enough to check point frogs

Buffer Lights

DC & DCC WIRE FREE OO HO N

Only £5



Track and buffer stop not included

- Add realistic stop light to any siding
- Simply clips onto track - No wires!
- Fits next to most buffer stops & kits
- Or at platform end or free standing
- On DCC both lights are on constantly
- On DC one light is on & varies with speed

DCC Fitted Digital Signals

DCC WIRE FREE OO HO



- Signal with DCC decoder built into base
- Can just plug direct into track - no wires!
- Easy to fit and use - no CV programming!
- Can sync to other signals & points
- Available with Feathers & Theatres

One-Touch DCC™ Point Controllers

DCC OO HO N Z



- Control points and uncouplers using DCC
- Work with most solenoid point motors
- Just connect 2 wires to DCC rails - No CV Programming!
- Easy screw terminals - no soldering
- Built in CDU for efficient operation
- Can sync to other points and signals

LFX Lighting Effect Controllers

DC & DCC ANY GAUGE



- Easily add lighting effects to your layout
- LEDs screw in - no resistors or soldering
- Powered by 9v battery, 9-16V DC or DCC
- On DC the effect is on when powered
- On DCC the effect can be controlled
- Effects LEDs are included

Level Crossing - Ready Assembled

DC & DCC OO HO N



- Power from 9-16v DC, DCC or a 9v battery
- Light and sound - all connections easy push fit
- Includes 2 x Peco static level crossing barriers
- Can turn on automatically using a Track Sensor
- Available in single and pair packs

Track Sensor

DC & DCC OO HO



- Change Semaphore Signals automatically (with SC300)
- Trigger Level crossing when train approaches
- Power from 12-16v smooth DC or DCC
- Links to a Mimic Switch to show occupancy
- Links to a Sensor Signal to change block section

Automatic Tail, Firebox & Loco Lights

DC & DCC Auto WIRE FREE ANY GAUGE

Rolling stock not included



Fits in N scale upwards

- No switch - senses motion & turns on!
- Turns off automatically 4 minutes after stop
- No pickup, wires or soldering - LED plugs in
- Fit in brake vans, coaches, loco, wagons etc
- Runs for ages on small button battery
- LEDs and battery included

Mimic Switches & Lights

DC & DCC ANY GAUGE



- Make a mimic panel to control LayoutLink items
- Link to Track Sensors or Sensor Signals to show occupancy & signal status
- Single wire to control Layout Link products
- Link to Sensor Signals to switch route indicators on/off

Signal Kits

DC & DCC OO HO



Every kit includes the signal head, aluminium post and base plus detailing kit

- Low cost - adapt to your own design
- Control by switches or signal controller
- LEDs are prefit to a narrow PCB

SK2+ Signal Kit



5 060325 130016

One-Touch DCC™ Signal Controllers

DCC ANY GAUGE

- Control LED & Semaphore signals by DCC
- Easy screw terminals - no soldering
- Easy to set up & use - No CV programming!
- Can sync to other points & signals

Automatic Sensor Signals

DC & DCC WIRE FREE OO HO



- Detects train and changes signal automatically
- Use on its own & signal changes back to green after time
- Or link to other SS for automatic block signalling
- Can be used on both DC & DCC
- Also available with Feathers & Theatres

Automatic Coach Lighting

DC & DCC Auto WIRE FREE OO HO



Rolling stock not included

- Easy to fit in seconds - no wiring!
- No switch - senses motion & turns on!
- Turns off automatically 4 minutes after stopping
- No pickups **so works on regular DC & DCC**
- Traditional warm white or modern cool white
- Also with tail light, sparks or door light effect
- Lights stay bright & constant with no flickering
- Fits most OO/HO coaches and maybe cut down

SFX Sounds for Trains

WIRE FREE DC & DCC Auto



- Easy low cost sound that works on *any* railway
- Easy to fit in seconds** - no connections
- No switch - senses motion & turns on!
- No pickups **so works on regular DC & DCC**
- Self contained - built in speaker & battery (included)
- Tiny capsule: 25mm x 20mm x 12mm approx
- Fit capsule into loco, tender, wagon, coach...
- Real recorded sounds** - Steam & Diesel etc

Smart Lights - Easy to fit Lighting Effects

DC & DCC ANY GAUGE



- Small - Just 1cm x 1cm x 0.3cm with 2 wire connections
- Power by standard 9-16v DC or a 9v battery
- Or by DCC which can also control some effects
- Just connect and go - no setting up required
- Disco / Emergency / Real Fire / TV / Welding / Random effects

Traffic Lights - Ready Assembled

DC & DCC OO HO



- Power from 9-16v DC, DCC or 9v battery - 2 Wire connection
- Realistic standard UK sequence and timing varies randomly
- Fully assembled - drill hole in baseboard & connect to power

SEE WWW.TRAIN-TECH.COM OR CONTACT DCP FOR FREE COLOUR BROCHURE



SK2+: Red-Green Self assembly signal kit

www.Train-Tech.com

See our website, your local model shop or contact us for a free colour brochure
 DCP Microdevelopments, Bryon Court, Bow Street, Great Ellingham, NR17 1JB, UK
 Telephone 01953 457800 • email sales@dcpmicro.com • www.dcpexpress.com