

## Train Tech overview - ask for free catalogue

**Signal kits** - OO/HO low cost easy to make signals for DC

**Sensor Signals** - easy automatic block signalling - DCC or DC

**Smart Lights** - small effects built in - DC/DCC - just 2 wires:  
Arc welding • Emergency vehicle • TV • Fire effect • Party disco

**Automatic Coach Lights** - motion - no pickups or wiring:  
Older Warm White • Modern Cool White • Tail Light • Spark Arc

**Automatic Tail Lights** - motion - easy, no wires - lantern LED:  
Flickering flame oil lamp • Modern Flashing • Constant light

**Track Tester** - quickly tests DC polarity or DCC - N-TT-HO-OO

**SFX+ Sound capsules** - no wires! - real trains - DC or DCC  
Steam • Diesel • DMU • Passenger coach • Shunted stock

**Buffer Light** - clip in lights for buffer stops - N or OO - DC/DCC

**LFX Lighting effects** - DC/DCC - screw terminals - with LEDs:  
Home & Shop lighting • Welding • Flashing Effects • Fire

**Traffic Lights** - fully assembled - just connect to DC or DCC

**Level Crossings** - assembled - N & OO versions - DC / DCC

**DCC fitted signals** - slide in the track - easy one touch setup:  
2 aspect • 3 aspect • 4 aspect • Dual head • Feathers • Theatre

**DCC Point Controllers**

**DCC Signal Controllers**

**LEDs**

**Tools etc**



COMPREHENSIVE CATALOGUE FREE ON REQUEST  
[www.train-tech.com](http://www.train-tech.com)

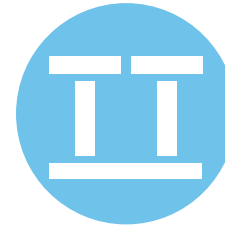

# Train-Tech

Model Technology Made Easy

## GS2 Yellow/White Ground Signal

- Modern & Original Stop light styles
- Easy mounting using cap supplied
- DCC controlled with built in decoder
- DC powered from 12-16V smooth DC
- Automatic operation by Track Sensor
- Control & indicate with Mimic switch

Signal Mounting cap

**OO Gauge Ground Position  
signal for both DCC and DC**

[www.Train-Tech.com](http://www.Train-Tech.com)

See our website, your local model shop or contact us for a free colour brochure  
DCP Microdevelopments, Bryon Court, Bow Street, Great Ellingham, NR17 1JB, UK  
Telephone 01953 457800 • email [sales@dcpmicro.com](mailto:sales@dcpmicro.com) • [www.dcpexpress.com](http://www.dcpexpress.com)

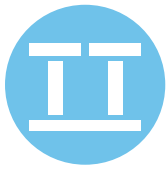

***Please handle carefully & read these instructions fully before installing!!***

## **Contents list:**

- GS2 Yellow-White Ground signal assembly
- Mounting cap: x 1 (2 part)
- Sample length of solid core wire 1/0.6mm
- Instruction guide

## **Introduction**

This ground signal is an accurate OO scale representation of ground signals as seen on real railways and they are usually found around fiddle and shunting yards. The two lower LED lights can be set to display either modern Yellow-Yellow or original Yellow-White style for Stop.

The built in electronics includes a digital decoder for DCC control, an input for a Track Sensor to control the signal automatically with train movement and another input for connection to a Train-Tech Mimic switch which can control the signal, indicate signal status and if Track Sensors are used also show train occupancy, all linked using a single wire.

It is beyond the scope of these instructions to explain exactly where to locate and use Ground Position signals (sometimes called Shunt Signals), but there are plenty of good books on railway signalling as well as many resources online. In essence, the main difference between a White/Yellow and a White/Red ground position signal is that Red always means Stop, whereas Yellow means Stop *unless* the route is not set in the direction for which the signal cannot be cleared.

***Please handle it with extreme care - as with most precision scale models it is fragile!***

## **Troubleshooting**

This product is designed to be easy to fit and use but here are a few tips which may help should you have problems following installation. Remember only wire and install with power turned OFF.

- Flickering lights when powered from DC?

Check that the DC is really smooth DC and not rough from a crudely rectified AC. Train-Tech offer a low cost capacitor smoothing unit to convert rough DC to smooth DC called SM1 and also Gaugemaster make a good quality 12V regulated and smooth mains power unit ideal for model railway electronics, part No WM4.

- Intermittent automatic operation?

If using Track Sensors which are powered using the slide in track fingers check that they are making good contact with the rails and that the sensor is close to but not touching the rail.

- Cannot program control by DCC?

This Ground Signal works on DCC Accessory addresses, not loco addresses, so check your DCC controller can control DCC accessories and make sure the controller is set to Accessory mode before you set up.

- Problems plugging in wires to the sockets?

The sockets fitted to the Ground Signals and Track Sensors are designed to be used with single core wire 1/0.6mm gauge or similar, as per sample supplied (sometimes called 'Bell Wire'). Do not use stranded wire as this will not fit properly and stray strands may not go into the socket and touch other contacts or components causing damage.

## • Installing the Ground Signal

Firstly, before fitting or connecting your Ground Signal **SWITCH OFF ALL POWER!**

The Ground signal has sensitive electronics which may be permanently damaged if stray wires touch components or connections. Please note that the circuitry under the signal head will run slightly warm - this is normal.

The picture below shows you what the parts do and the instructions to show how to power and control your Ground Signal are on the following pages - choose the appropriate page for your power system & layout.

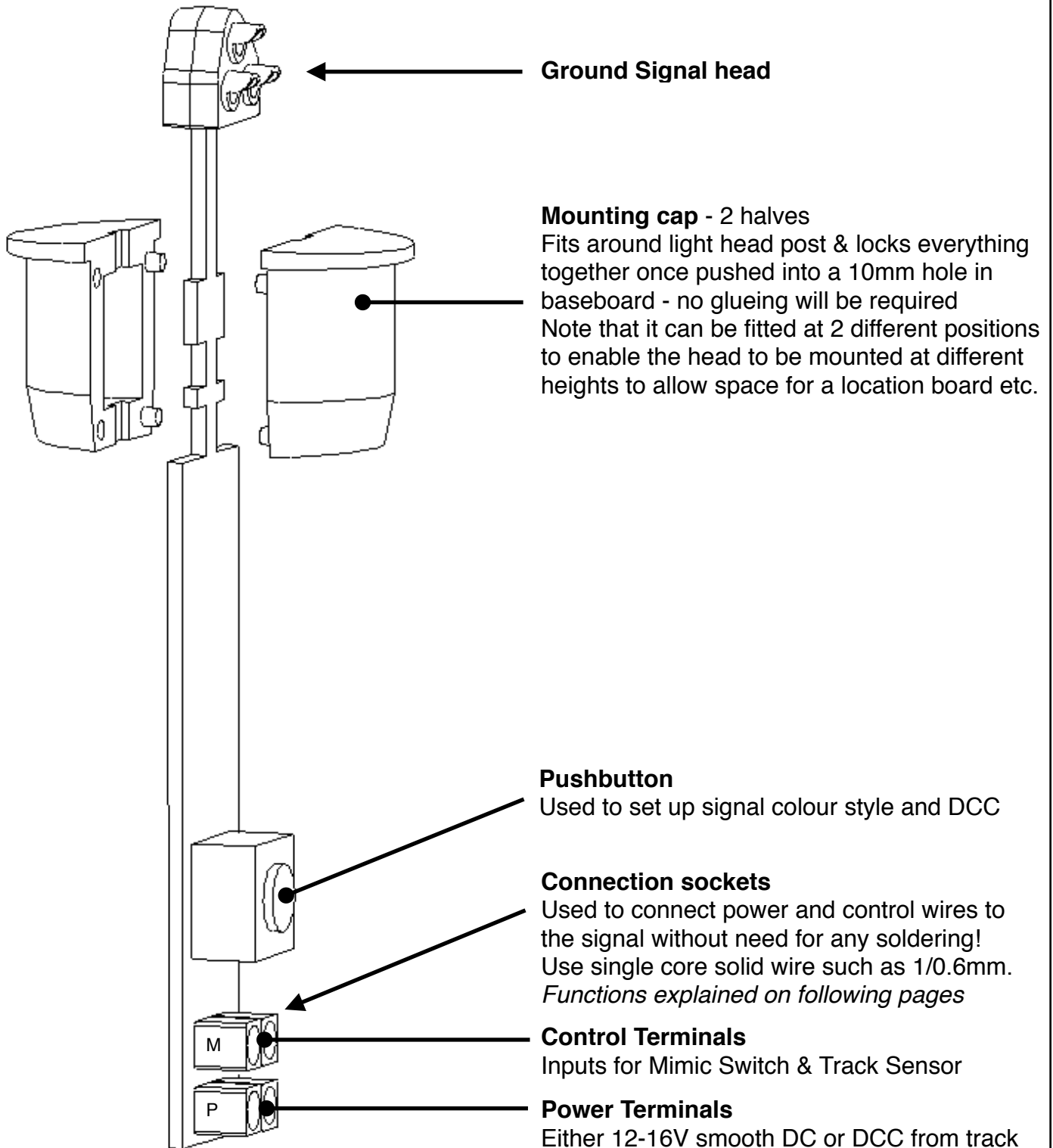

## • Control and power by Digital DCC

This section shows how to power and control your ground signal using Digital DCC. Most DCC controllers or PC based systems should be compatible as long as they are capable of controlling DCC **accessory** addresses (as opposed to only DCC locomotive addresses).

You can power the signal easily with 2 wires connected from the nearest DCC supply (eg Track, bus bar or controller output) and the bottom two connection sockets marked P on the signal. Setup is easy using Train-Tech One Touch DCC; Just choose an **accessory** address on your controller or PC, press the Learn button on the Crossing and finally send a direction or 1 or 2 command from your controller to set it up (commands vary between controllers - see instructions).

We recommend all signal connections are made using solid single core wire which simply plugs into the sockets (not stranded wire as stray whiskers of wire can short to other components.)

**Caution - Only make connections with ALL POWER OFF and ensure you never touch any other metal terminals or components otherwise permanent damage will result. Never use AC or any voltage over 16 volts DC - if in doubt check supply with a voltmeter.**

### One Touch DCC - easy setup

- 1) Wire your signal as below and turn the DCC power on
- 2) Choose a DCC **accessory** address for your ground signal and select it on your controller

3) Press the Pushbutton to alternate between the style of Stop signal lights you want - the LED lights will alternately flash as follows:

Original Style: Stop = Yellow+White  
Modern Style: Stop = Yellow+Yellow

*Leave the signal flashing the style you choose to use*

4) Send a direction command ◀ or ▶ / 1 or 2 (the exact command will depend on your controller - refer to your controller instructions on using Accessory commands). The signal will display Proceed (2 whites) and has set your chosen address into the signal which you can now control using the accessory address you set.

*Tip* If you choose the same address for your signal as another signal or DCC controlled point they will change together. Note that the ◀ or ▶ / 1 or 2 command you use to set it up always sets the signal to Proceed.

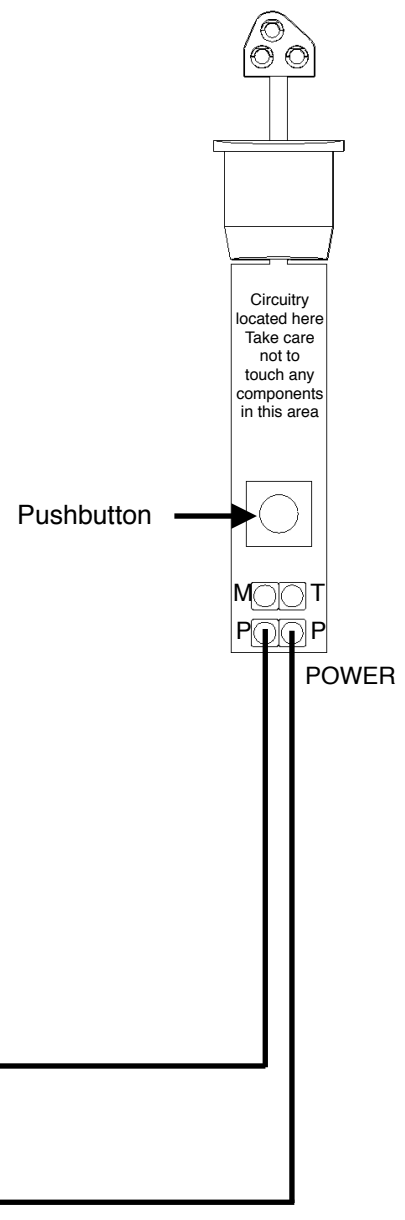

Connect to the nearest DCC rails, DCC controller output terminals or a DCC bus if you have one

# • Control and power by Analogue DC

This page shows how to power and control your Ground signal using traditional 12-16V smooth DC - sometimes called analogue.

You can power and control this signal easily using just 2 wires from your smooth DC supply to the bottom 2 connections marked P on the signal. By reversing the polarity, the signal will change its state from Stop to Proceed. Using DC control, if the left hand P terminal is positive the signal will show Stop (yellow), if the right hand terminal is positive it will show Proceed (2 whites).

You can reverse the polarity in several ways, but most conveniently using a DPDT (double pole double throw) switch, such as the toggle switch in Train-Tech pack TS1.

We recommend connections are made using solid single core wire (bell wire) which simply plugs into the sockets (not stranded wire as stray whiskers of wire can short to other components.). A 1m sample is included but more can be bought from Train Tech (WP2/WP3) and most electrical suppliers - it is sometimes called 1/0.6mm wire which means 1 core 0.6mm diameter.

**Caution - Only make connections with ALL POWER OFF and ensure you never touch any other metal terminals or components otherwise permanent damage will result. Never use AC or any voltage over 16 volts DC - if in doubt check supply with a voltmeter.**

## Ground signal colour style

This signal can be set to display either the original Yellow+White stop light or the modern Yellow+Yellow stop light.

- 1) Wire your signal as below, turn the DC power on and using the switch change polarity so that the signal lights up the two lower LED lights.
- 2) Press the Pushbutton on the signal to alternate between the style of Stop lights you want to display - the bottom 2 LED lights will alternately display as follows:

Original Style: Yellow+White  
Modern Style: Yellow+Yellow

*Leave the signal showing the style you want to use*

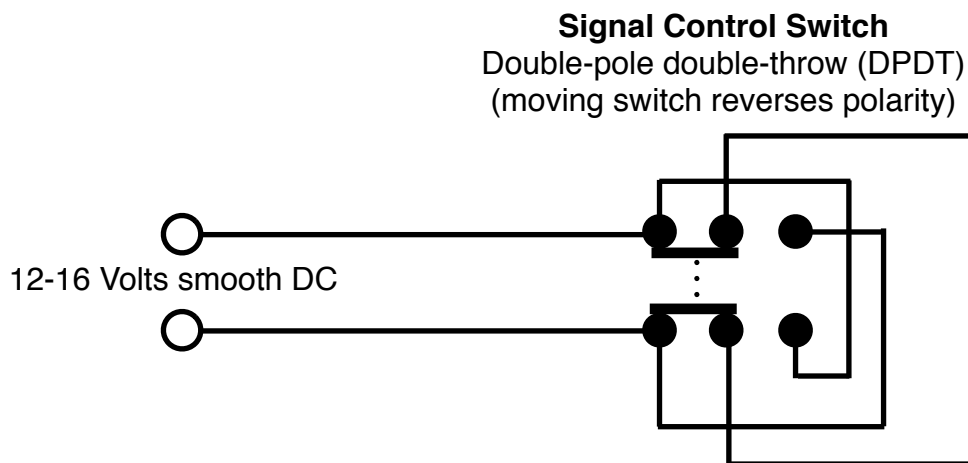
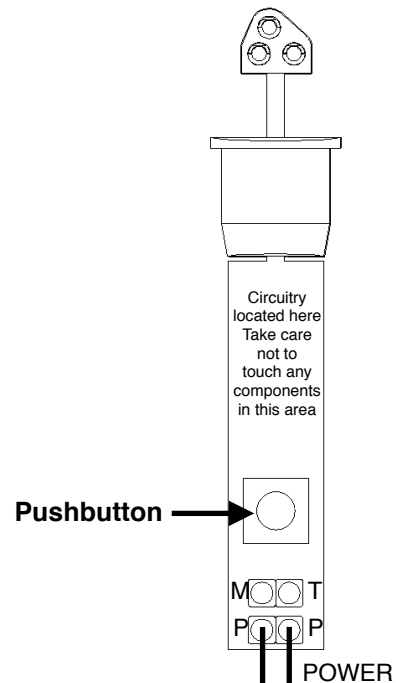

*Above is the schematic for a DPDT switch but also represents the same wiring layout for the connections on many toggle and slide switches*

## • Control using a Mimic Switch - powered from DC or DCC

As well as being controlled by Track Sensor, DC or DCC, your Ground signal can also be controlled by a Train-Tech Mimic Switch. The Mimic Switch is connected to the signal using a single wire and should be powered from the same power supply which can be DC or DCC. For details of how to connect DC or DCC power and to set up the signal style see the relevant page in this manual.

The drawing below shows how to connect a mimic switch to the Ground signal using a single wire. On a MS1 Toggle Mimic Switch the up position is Proceed and the lower position is for Stop - *note that the MS1 Mimic Switch takes priority over either DCC control or Track Sensor*. The centre position of the toggle switch allows the signal to be controlled by either DCC and/or Track Sensor. On a MS2 Pushbutton Mimic you can change signal from Proceed to Stop by pressing the button. As well as controlling the signal, either type of Mimic Switch or a ML1 Mimic Light also remotely shows signal status and, if also using a Track Sensor, occupancy of the train.

**Caution - Only make connections with ALL POWER OFF and ensure you never touch any other metal terminals or components otherwise permanent damage will result. Never use AC or any voltage over 16 volts DC - if in doubt check supply with a voltmeter.**

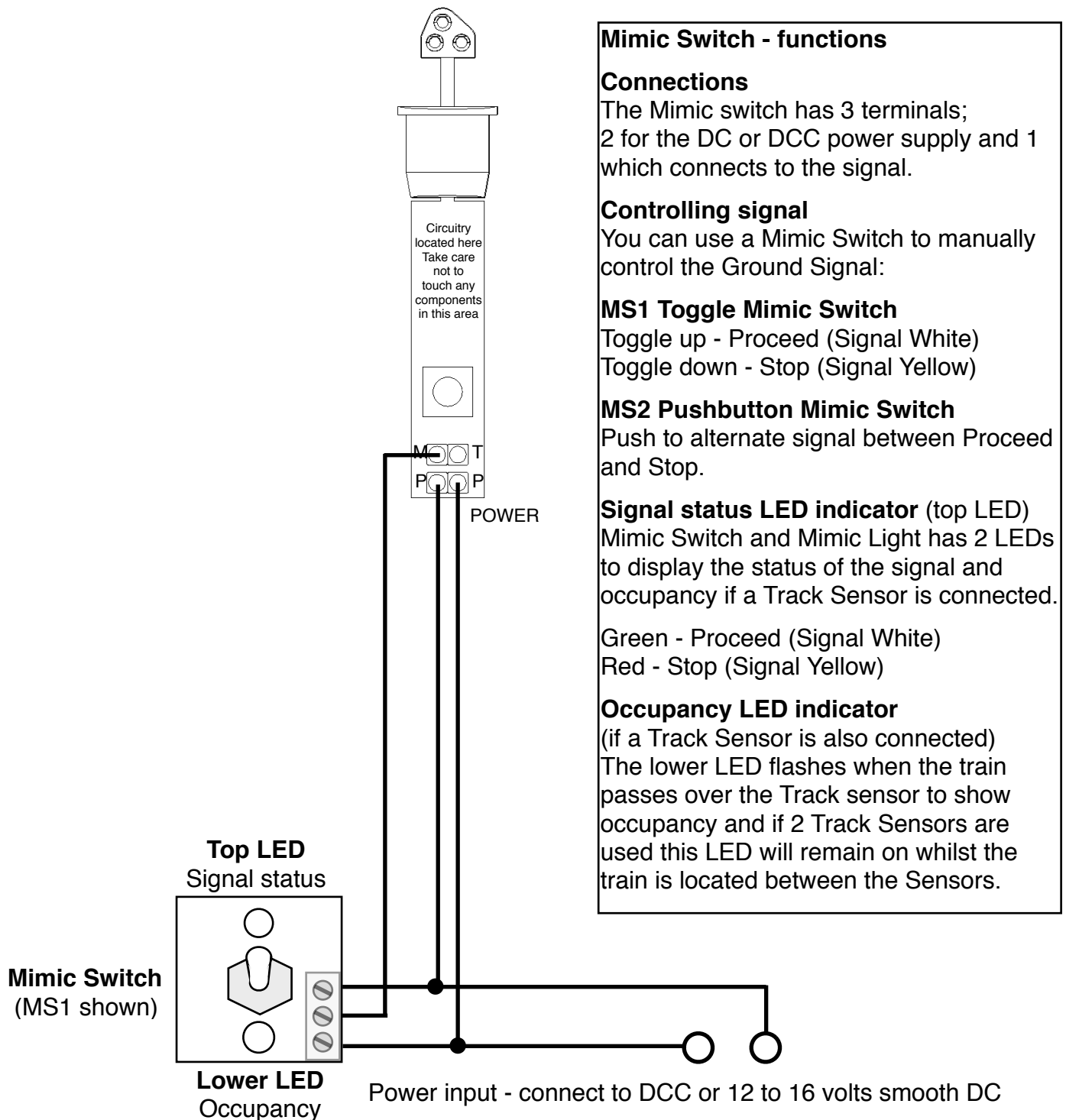

### Mimic Switch - functions

#### Connections

The Mimic switch has 3 terminals; 2 for the DC or DCC power supply and 1 which connects to the signal.

#### Controlling signal

You can use a Mimic Switch to manually control the Ground Signal:

#### MS1 Toggle Mimic Switch

Toggle up - Proceed (Signal White)

Toggle down - Stop (Signal Yellow)

#### MS2 Pushbutton Mimic Switch

Push to alternate signal between Proceed and Stop.

#### Signal status LED indicator (top LED)

Mimic Switch and Mimic Light has 2 LEDs to display the status of the signal and occupancy if a Track Sensor is connected.

Green - Proceed (Signal White)

Red - Stop (Signal Yellow)

#### Occupancy LED indicator

(if a Track Sensor is also connected)

The lower LED flashes when the train passes over the Track sensor to show occupancy and if 2 Track Sensors are used this LED will remain on whilst the train is located between the Sensors.

# • Automatic control using a Single Track Sensor

As well as controlling the Ground Signal manually by a switch or DCC you can also control it automatically using a Track Sensor, so that when a Train approaches the signal changes to show proceed until the train has passed, then after 7 seconds changes back (see the following page to see how to connect an additional track sensor to change the signal back instead of time).

The Track sensor must be powered by the same power as the Ground Signal which can either be Digital DCC or Analogue 12-16 Volts smooth DC and just a single wire links from the middle socket of the Track Sensor to the right hand socket of the Ground Signal marked T - see below.  
*(Note Sensor Signals also perform like Track Sensors so can also be used to control GS Signals)*

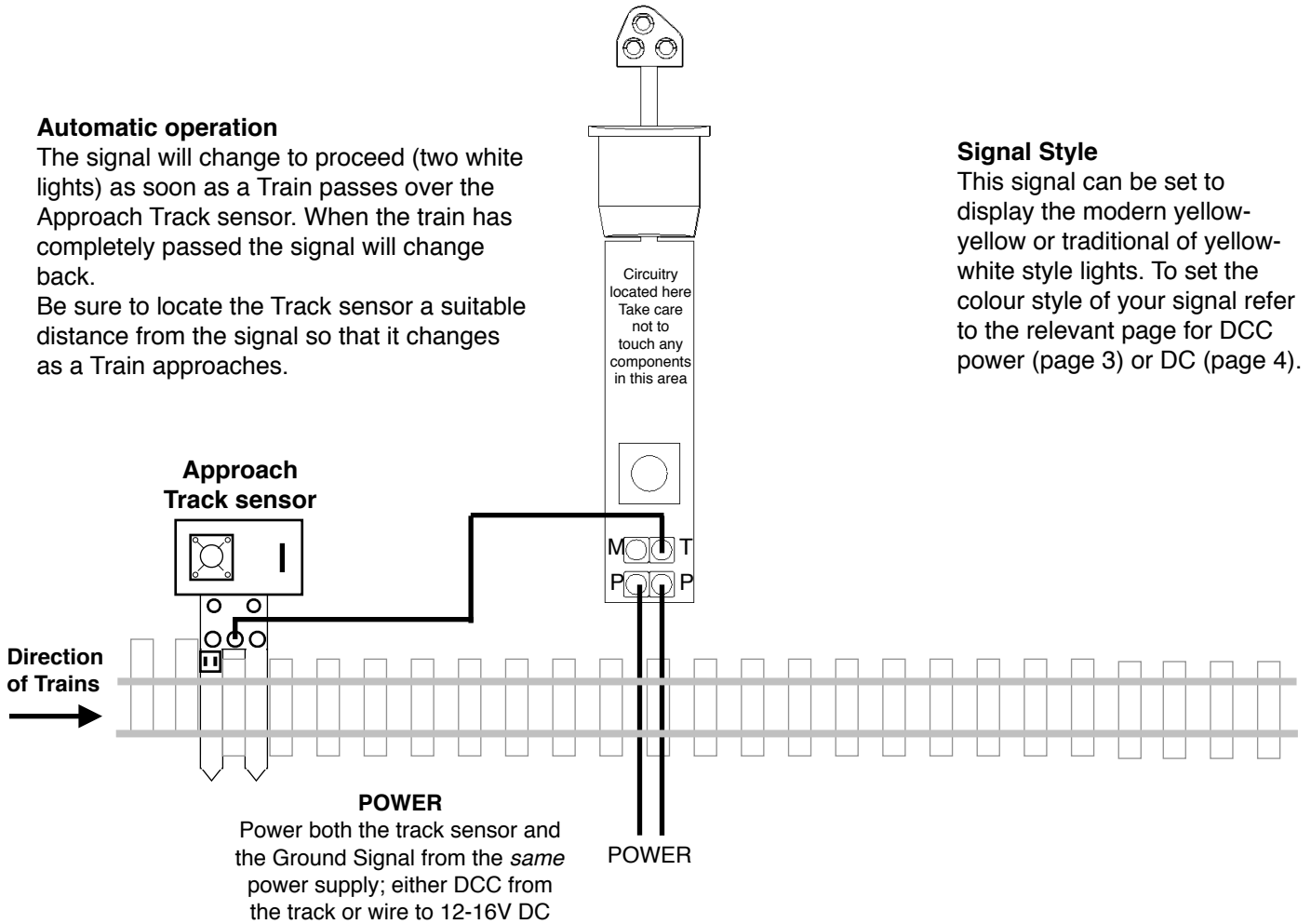

## Powering the Track sensor

If used on DCC a Track Sensor can either be clipped straight into some types track in the power clip slots (eg Hornby or Bachmann) but if not the slide-in fingers can be cut off and the two connections shown wired to either DCC or 12-16 Volts DC - see below.

### Power by sliding sensor into track - for DCC

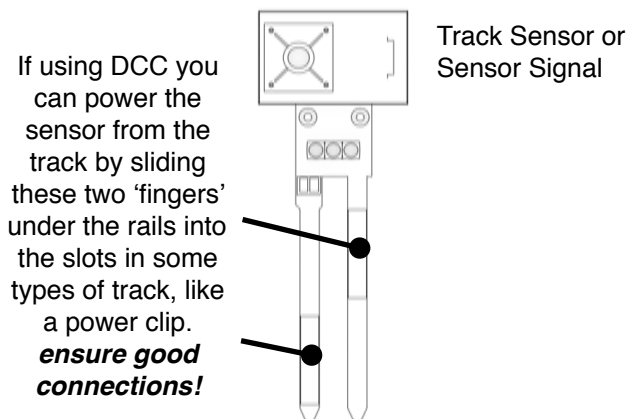

### Power by wiring to sensor - for DC or DCC

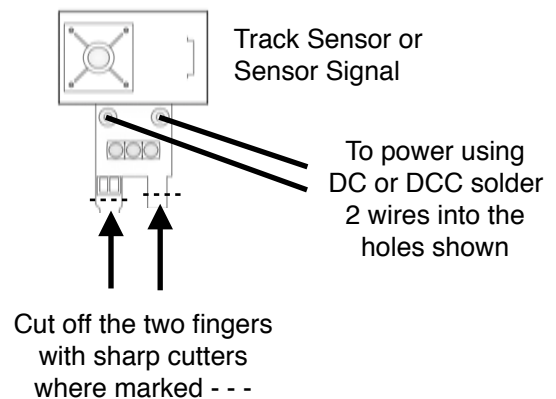

# • Automatic control using Two Track Sensors

The previous page shows how a Track Sensor can be fitted to change the signal to proceed as the train goes past it, then after fixed time the signal will go back to stop.

Instead of the signal changing back a certain amount of time after the train has passed, you can add another Sensor to only change it back when the train passes the second Track Sensor. A single wire is all that is needed to link the additional Track Sensor to the first as shown below.

Both Track sensors must be powered by the same power as the Ground Signal which can either be Digital DCC or Analogue 12-16 Volts smooth DC. A single wire links from the middle socket of the first Track Sensor to the right hand socket of the Ground Signal marked T - see below.

*(Note Sensor Signals also perform like Track Sensors so can also be used to control GS Signals)*

### Automatic operation

The signal will change to proceed (two white lights) as soon as a Train passes over the first (Approach) Track sensor. When the train has completely passed the second (Return) Track Sensor the signal will change back.

Be sure to locate the Track sensors suitable distances from the signal so that it changes as a Train approaches and back after it passes the second Track Sensor.

### Signal Style

This signal can be set to display the modern yellow-yellow or traditional of yellow-white style lights. To set the colour style of your signal refer to the relevant page for DCC power (page 3) or DC (page 4).

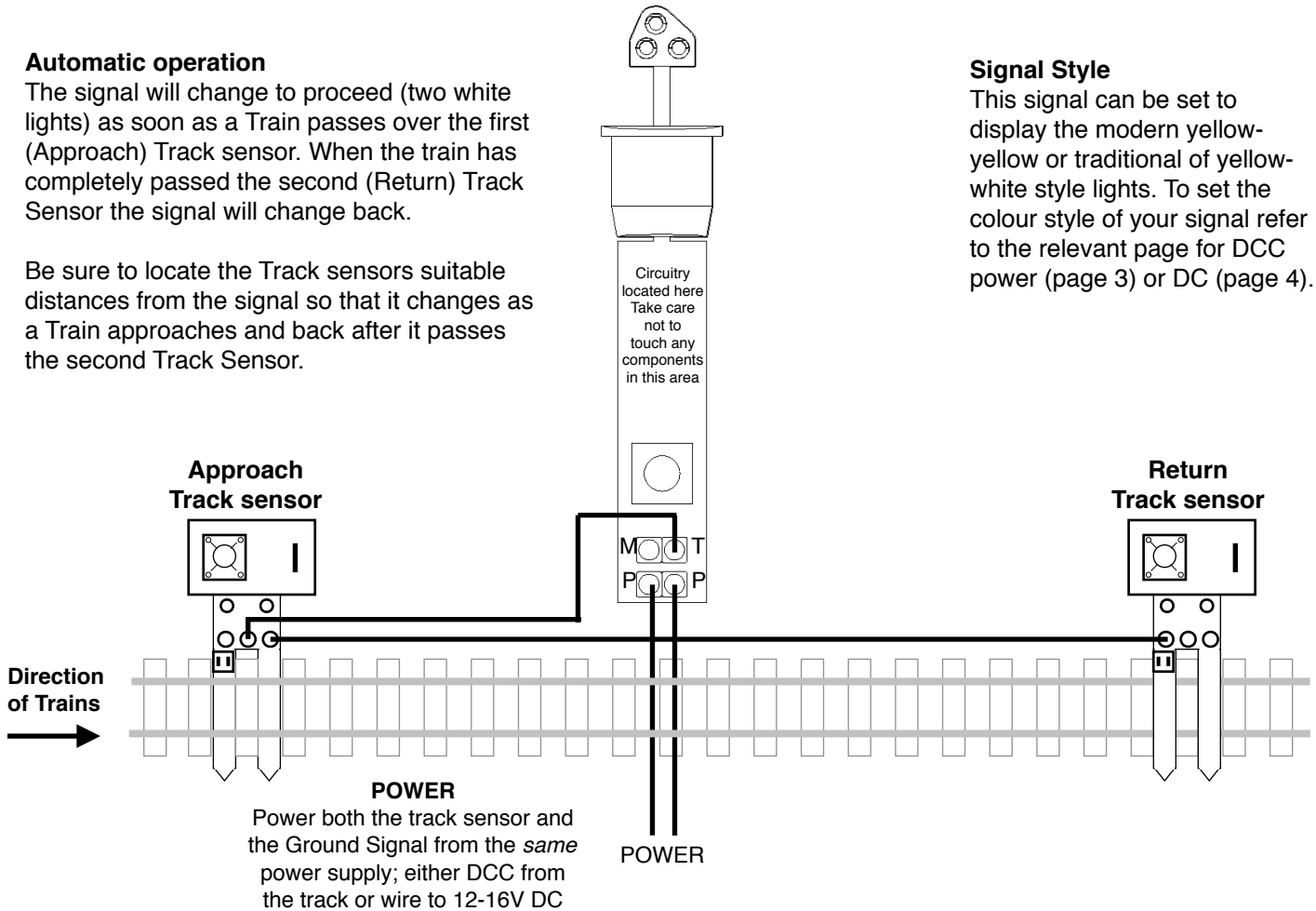

### Powering the Track sensor

If used on DCC a Track Sensor can either be clipped straight into some types track in the power clip slots (eg Hornby or Bachmann) but if not the slide-in fingers can be cut off and the two connections shown wired to either DCC or 12-16 Volts DC - see below.

#### Power by sliding sensor into track - for DCC

If using DCC you can power the sensor from the track by sliding these two 'fingers' under the rails into the slots in some types of track, like a power clip. **ensure good connections!**

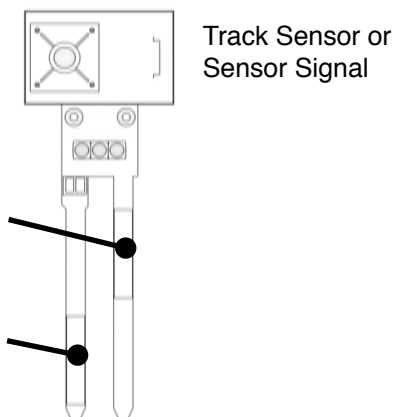

#### Power by wiring to sensor - for DC or DCC

